

# Fire Stop Blocks

Fire and smoke stop blocks for apertures in buildings, especially the flutes of trapezoidal formwork.

## PRODUCT

AIM Fire Stop Blocks are made from high density Rockwool stone wool. Incorporated into the building during construction, they are used to seal apertures and are permanently held in place by compression. They can also be used within metal cladding as a fire break and to protect the top flange of steel beams.

AIM Fire Stop Blocks are predominantly supplied as trapezoidal sections. Square cut, rectangular or round sections are also available.

## APPLICATIONS

Used to seal imperfections of fit within the construction and maintain fire compartment lines.

Predominantly supplied as trapezoidal sections, square cut, rectangular, round or sinusoidal sections also available.

Applications

- Composite Flooring Profiles
- Dovetail Composite Flooring Profiles
- Metal Decking, Roofing and Cladding

Fire Stop Blocks are designed for use in trapezoidal formwork (metal decking) typically at the head of a wall (as shown in the illustrations)

Fire Stop Blocks may be used elsewhere in a building and may require approval, for example filling holes within a building.

AIM Fire Stop Blocks can be used at the head of a partition wall if the head track is fastened to the metal deck.

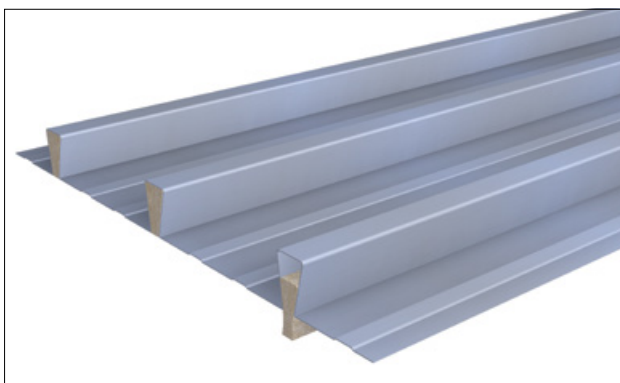
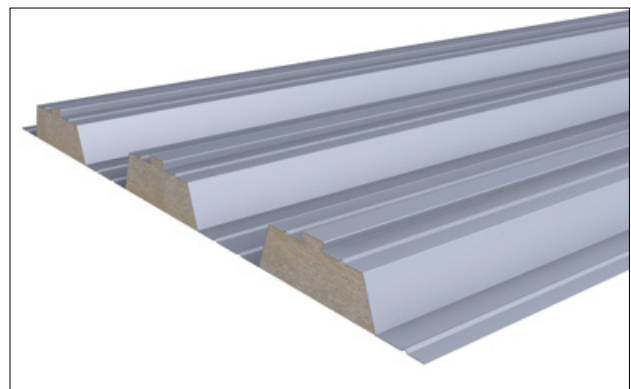

## FEATURES

- Simple to install – no tools required.
- 1 and 2 hour fire rating.
- Ablative / pre-painted option available.
- Manufactured to any profile or customers dimensions.
- Up to 1200mm long.
- Available for metal deck profiles of up to 225mm deep.

## BENEFITS

- Maintains fire compartment lines.
- A barrier to the movement of smoke.
- Contributes to acoustic performance of the wall or partition.
- Many profiles CNC Cut for ultimate accuracy especially for profiles with rounded shoulders.
- Compression fit so no mastics or sealants required for most applications.
- Tested to the principles of EN 1366-4.

## PHYSICAL INFORMATION

- Minimum block length: 100mm
- Maximum length = 1200mm
- Minimum block height = 10mm
- Max block height = 225mm
- Dimensions to suit the profile / width of the wall
- Tested to the principles of EN 1366-4 in composite metal decking

The AIM Fire Stop Blocks can be manufactured to suit any metal decking profile. In many instances we already hold detailed data regarding the specification of leading brands of metal deck.

If this information is not available we can also manufacture blocks to the customers specification for this option we will need the following dimensions:

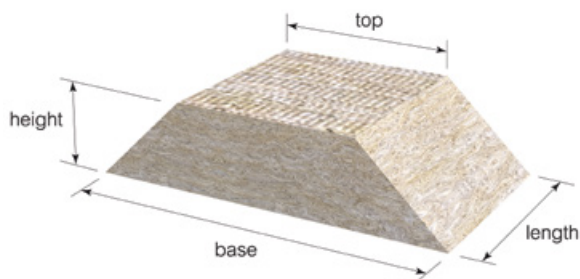

We will also need to know if your customer requires a special length of block (i.e. to match the width of a wall or partition) or if a specific fire rating is required.

## Majors and minors:

The minor block sits above the major block to fill the dovetailed web stiffener. (Sometimes this minor void is completely filled with an intumescent mastic)

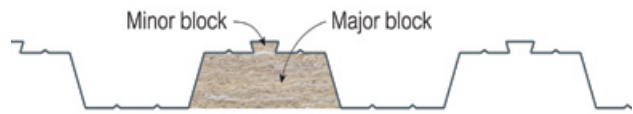

## Large and small flute:

Viewing the profiled decking from the panels end; the larger of the trapezoids is the large flute, (the smaller being small flute). Either large or small flute may be required depending upon which way up the decking is laid.



## ANCILLARIES

AIM Fire Stop Blocks are often used in conjunction with:

- AIM Fire Stop Strips which are used as a deflection head detail with masonry walls.
- AIM Acoustic Trough Infills where perforated metal sheeting is used as to form a roof structure and the flutes require an acoustic filler.

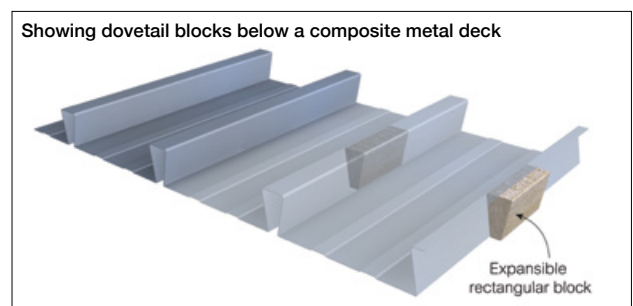
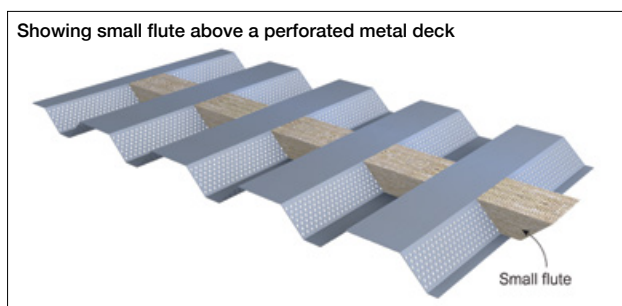
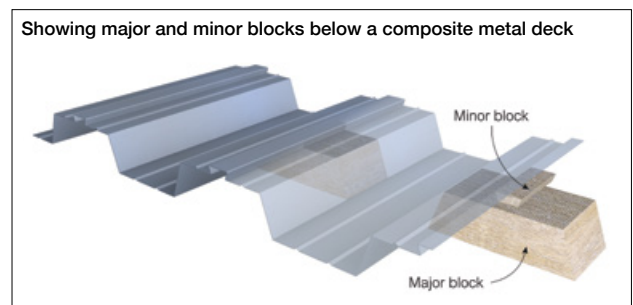
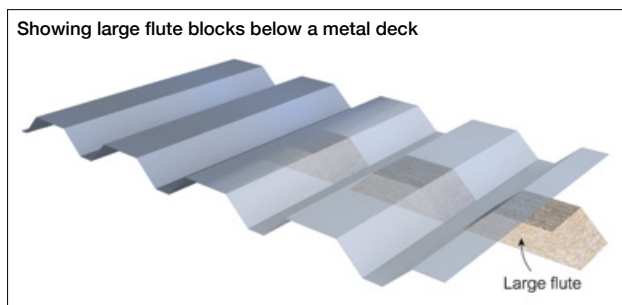

## Advanced Manufacturing Capability

AIM's investment in CNC Wire Saw technology enables the manufacture of Fire Stop Blocks to suit almost any metal deck profile irrespective of the complexity of the design.

The Fire Stop Blocks are manufactured using the CAD details from the metal deck manufacturer. The cutting process then faithfully follows the exact outline of the metal deck profile, including any stiffeners or other design features.

This capability can be applied to a variety of insulation materials but typically, for Fire Stop Blocks this is primarily Rockwool Stone wool or Rockwool Ablative Coated batts.

AIM's CNC Wire Saw Cutting technology can also be adapted to the manufacture of fire stop blocks to sinusoidal profiles or other, bespoke metal sheet patterns. The resulting fire barrier may require the approval of a competent person where a specific fire performance is required.

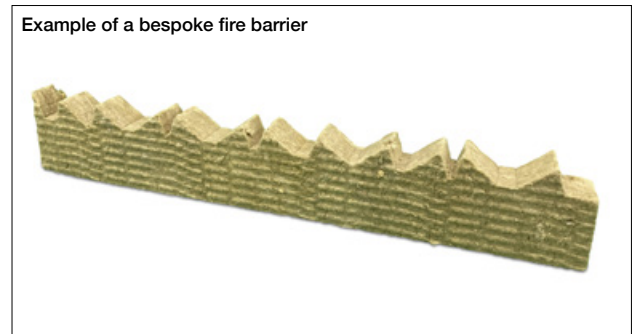

May require the approval of a competent person where a specific fire performance is required.

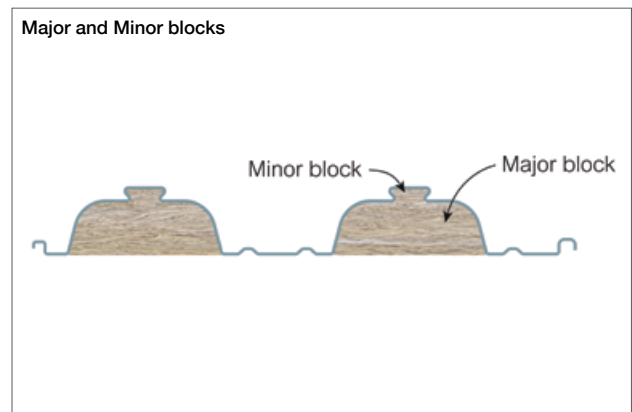
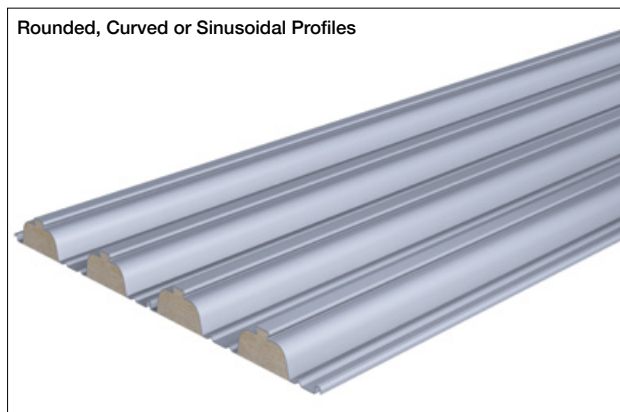

Fire Stop Block for a CF80 Profile



Fire Stop Block for an MD60 Profile



Fire Stop Blocks Small and Large Flutes for a D100 Profile



## Examples of common metal deck profiles

Fire Stop Block TR80 Major Block



Fire Stop Block TR60 Major and Minor Combi Block



Fire Stop Block D159 Large Flute



Fire Stop Block D159 Small Flute



Fire Stop Block CF60



Fire Stop Block MD146



Fire Stop Block D100



Fire Stop Block Sigma 100



## Range of Ablative coated batt Fire Stop Blocks



AIM Ablative Fire Stop Blocks are ideal for applications where aesthetics or fibre migration are a concern. Used to close the flutes above internal fire rated walls and partitions they maintain the fire compartment line and provide a high acoustic performance (up to 34dB / single layer) when sealed around their perimeter (on both faces) with AIM Intumescent Mastic.

Ablative Fire Stop Blocks are cut using CNC technology ensuring their accuracy making the installation faster and tidier than conventional straight sided trapezoidal sections.



### OPTIONS: FLEXIBLE WALLS

There are occasions when a metal deck will span across and flexible wall and will require the profile to be fire stopped with a fire stop block. Although this configuration has not been tested, it is good practice to install the Fire Stop block to match the width of the

flexible wall. To suitably restrain the head of a flexible wall, suitable fixings should be used to secure the head track to the soffit of the profiled metal deck between each flute.

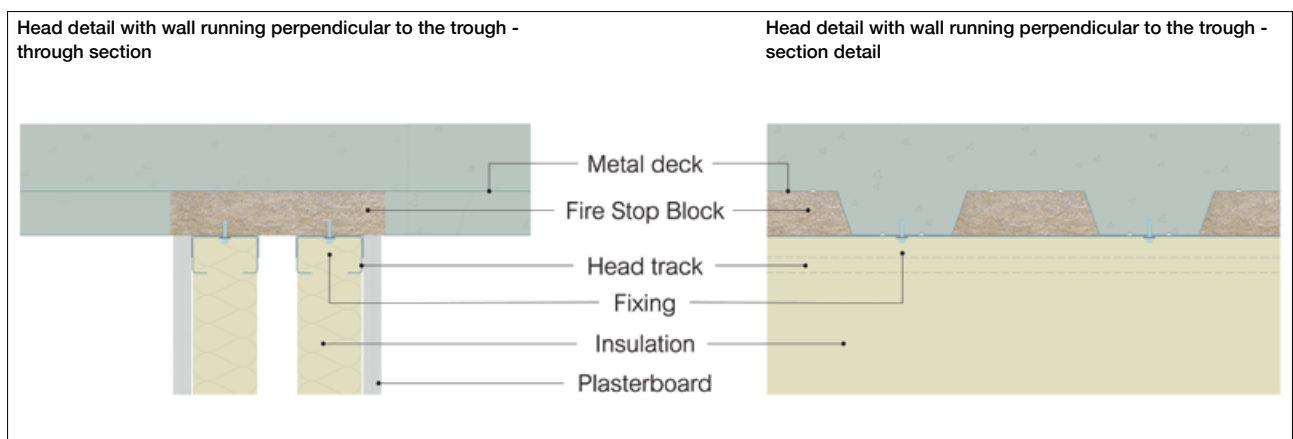

## OPTIONS: LINEAR FIRE STOP BLOCK

AIM Linear Fire Stop Blocks are used in composite panel constructions where a compartment line needs to be extended through the panel.

AIM's CNC Wire Saw enables the production of a linear fire barrier that is effectively the combination of several Fire Stop Blocks and a Fire Stop Strip into a single item.

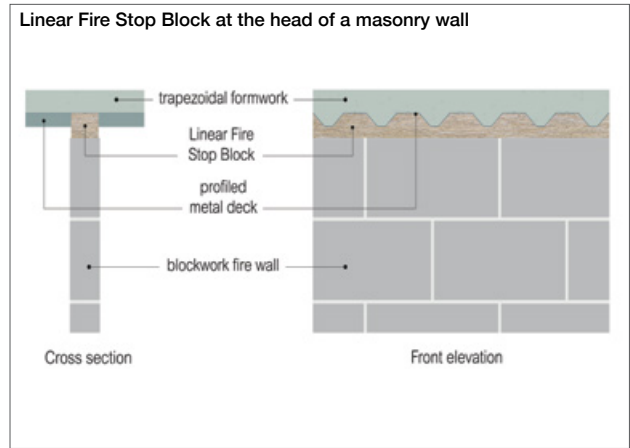
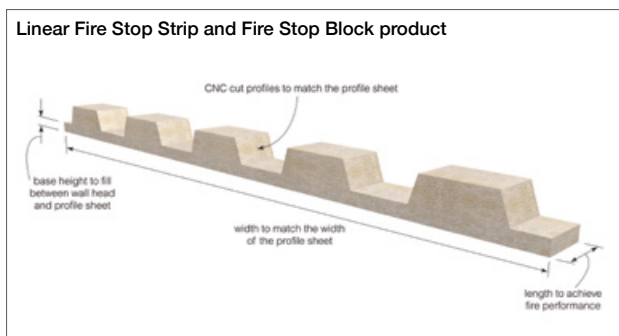

## A COMBINED SOLUTION FOR FLAT ROOFING

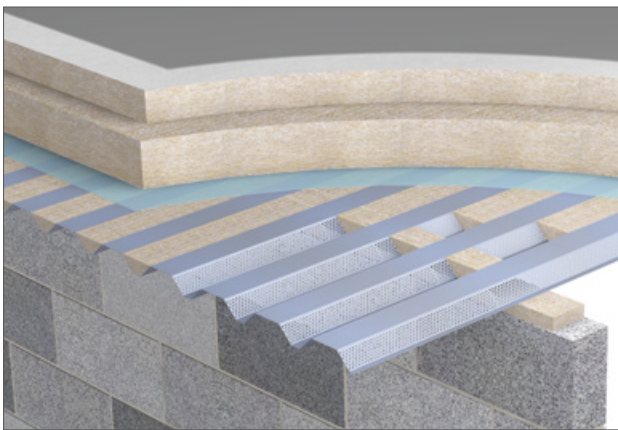

Where a fire wall is built to the underside of a perforated metal deck, AIM Fire Stop Blocks should be installed above and below deck at the line of the wall to ensure that smoke or fire is prevented from passing through the perforations in the metal work.

AIM Fire Stop Strip can also be used to remove any imperfections in the head of the wall to the underside of the metal deck.

AIM Acoustic Trough Infills are then used across the metal deck, to assist with the reduction of noise reverberation from within the building.

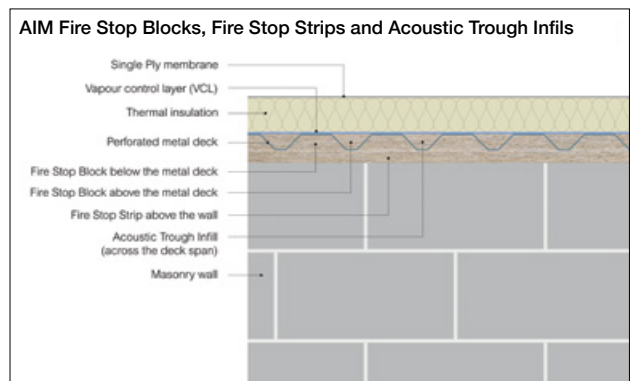

## TECHNICAL INFORMATION

### Fire Performance

The product achieves Euroclass A1.

### Fire Rating (Integrity / Insulation)

Metal Deck Profile	Tests Conducted in a composite metal deck with masonry below		
	Standard 100mm	Standard 125mm	Ablative 60mm*
C19	120/60	120/120	120/120*
CF80	120/60	120/120	120/120*
CF225	120/60	120/120	N/A

\* To be sealed in situ using AIM Acrylic Intumescent Mastic.

They are installed under compression (minimum 5% compression required).

Fire Stop Blocks may be used elsewhere in a building but will require approval.

Can be used at the head of a partition if the head track is fastened to the metal deck but should be approved by a Fire Engineer or Building Control.

### Acoustic Performance

AIM Fire Stop Blocks provide at least 18dB  $R_w$  sound reduction. The acoustic performance of the floor and wall systems must also be considered when assessing the room-to-room sound reduction figure.

100mm long block = 18dB  $R_w$

140mm long block = 23dB  $R_w$

### Air leakage

AIM ablative coated fire stop blocks provide a robust solution to air leakage requirements. These are available to suit most major cladding and decking profiles. In such instances, to prevent fibre migration from the stone wool, AIM intumescent mastic must be used to seal the perimeters of the Fire Stop Block.

### TEST REPORTS

WF 521746

Z11012 – Acoustic Performance. EN ISO 10140-2.



AIM are partners with NBS. Our products can be found on NBS Source and have been authored to NBS specification standards and have both CAWS and Uniclass 2015 classifications.

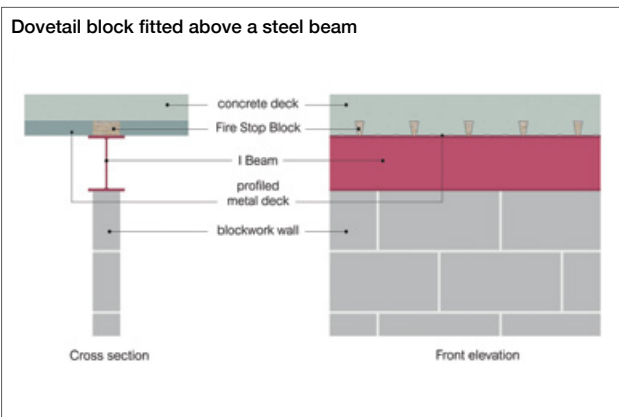
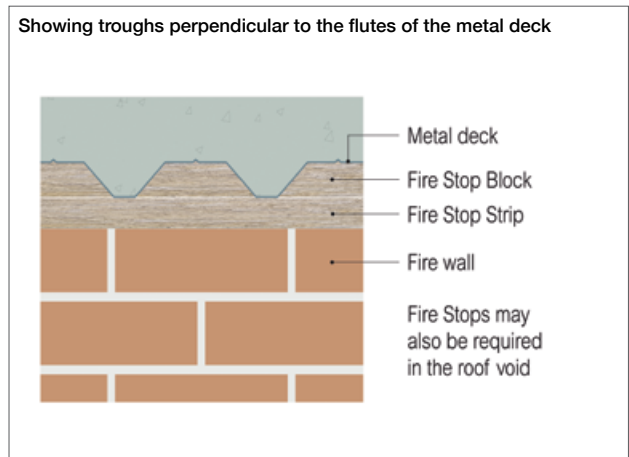
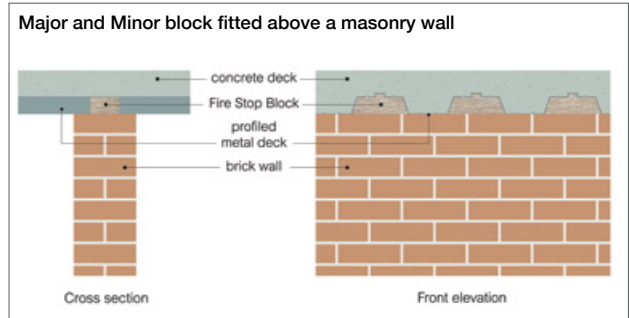
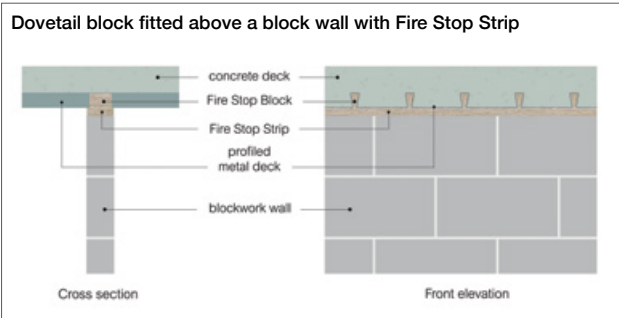
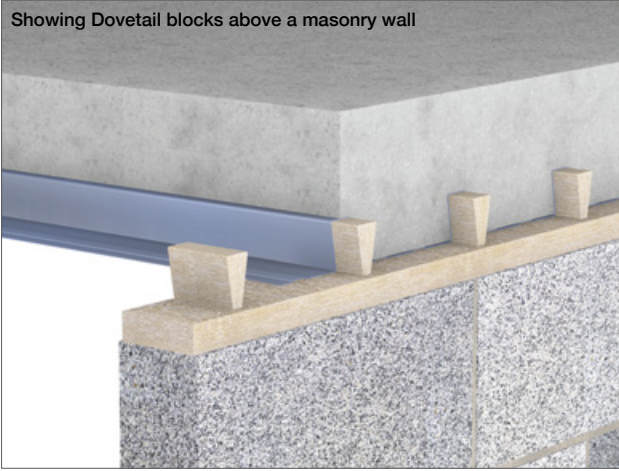



## INSTALLATION GUIDELINES

AIM Fire Stop Blocks are push fitted into place; they must fit tightly and completely. Dovetail fire stops are supplied as rectangular blocks, which are pinch fitted into the profile, then pushed into place.

### Items required for installation



PPE abrasion resistant gloves



PPE impact resistant goggles



RPE dust mask

- 1 Measure the Fire Stop Block to check it is the correct profile. Check the length of the Fire Stop Block is the correct length to achieve the correct fire performance, or match the width of the flexible wall/partition.



- 2 Fit the Fire Stop Block into the opening. It should fill the void completely. Any minor gaps or voids should be sealed with a fire rated intumescent mastic.

AIM Ablative Fire Stop Blocks should be installed in the same way but all perimeter sealed with AIM Intumescent Mastic on both faces.

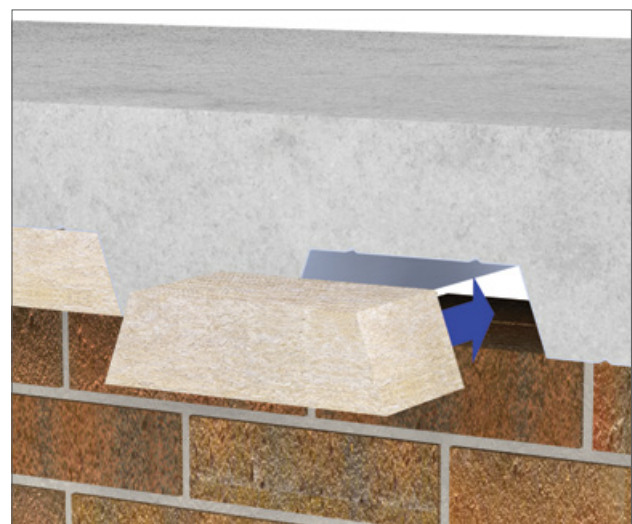

- 3** Holorib or dovetail blocks are supplied as square sections pinch fitted through the neck of the profile.



- 4** Once the Fire Stop Block is pushed through the neck of the profile it will expand to fill the void. Slide the Fire Stop Block into position over the firewall.

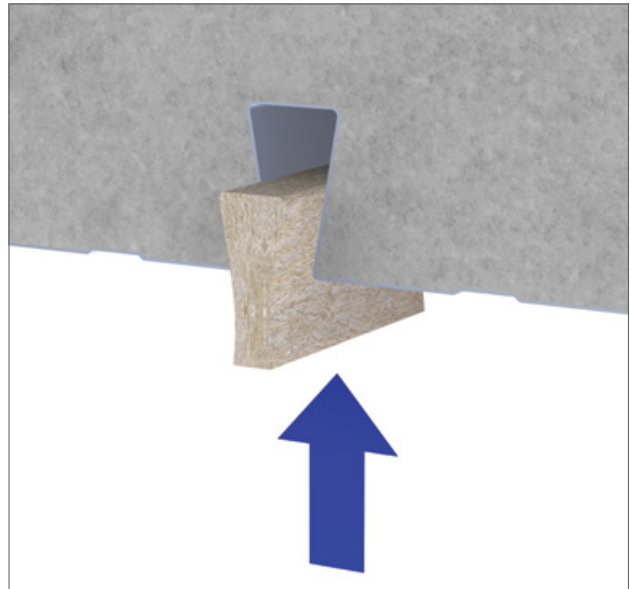

- 5** When fitting Major and Minor blocks, insert the minor profile first.  
A slip plate may assist in fitting the major block above rough surfaces.

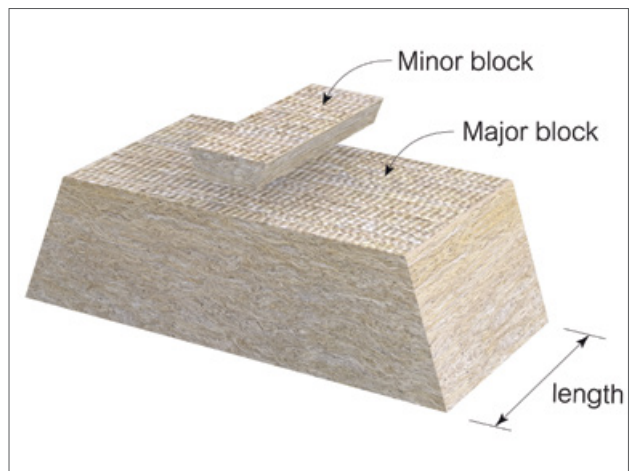

## STORAGE

Products are supplied in cartons and on wooden pallets with edge protection and a shower proof hood. Products should be stored away from the elements until ready for installation.

## MAINTENANCE

This product does not contain moving parts and, if undisturbed in the cavity, requires no routine inspections or maintenance.

It is recommended that the integrity of the barrier is rechecked if further works are carried out, which may involve disturbing the product.

## DURABILITY

AIM fire barriers are chemically inert, will not sustain vermin and do not encourage the growth of rot, fungi, moulds or bacteria. They are compatible with all normal building materials. They do not degrade under the usual conditions found in buildings and will perform effectively for the life of the building.

## HEALTH & SAFETY

Insulation products supplied by AIM are considered to be inert articles and as such are exempt from requirements to provide a Safety Data Sheet.

A Product Safety and Handling Information Sheet is available upon request.

## ENVIRONMENT

Global warming potential = zero

The stonewool element of the products originate from Rockwool UK. It may be possible to recycle clean and uncontaminated material under Rockwool UK's Rockcycle® service. Please contact Rockwool on 01656 868400 for further details.

## ORDERING

To order this product the following information will be required:

- The manufacturer and reference for the metal deck. Typically a metal deck reference will be along the lines of: Wards MD60, Corus CF70, SMD TR60, Rigidal 20/100/1000 and similar

- If this information is not available we can also manufacture blocks to your customers specifications; for this option we will need the following dimensions:

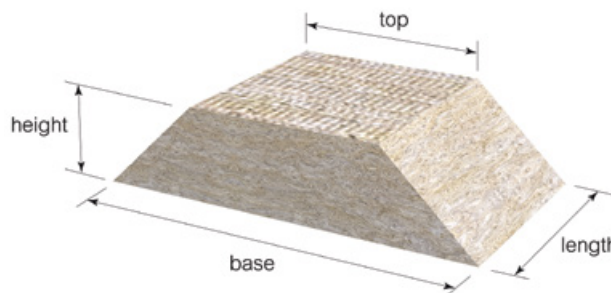

- We will also need to know if your customer requires a special length of block (i.e. to match the width of a wall or partition).
- Fire Performance required
- Approximate quantity.
- Delivery location.

All AIM fire barriers are made to order. Products are typically supplied in seven to ten working days but lead times may vary depending on existing factory commitments.

There is no minimum order quantity or value although small orders may attract transport surcharges.

## TECHNICAL SUPPORT

Technical Support is available from our experienced sales team on 01293 582 400 or [sales@aimlimited.co.uk](mailto:sales@aimlimited.co.uk)

## ABOUT AIM

AIM are a quality insulation convertor with over 30 years experience in the design, testing & manufacturing of high quality fire barriers for customers worldwide.

## VERSION CONTROL

Issue 4 - 06 2024

This document replaces and supersedes all previous versions.

The current version number can be verified at <https://www.aimlimited.co.uk/downloads/> or call AIM on 01293 582400

AIM are members of

AIM working in partnership with



T 01293 582400  
E [sales@aimlimited.co.uk](mailto:sales@aimlimited.co.uk)  
W [www.aimlimited.co.uk](http://www.aimlimited.co.uk)

**IMPORTANT:** The information provided within this document is believed correct and to the best of our available knowledge as at its revision date. The information should only be used as guidance for safe handling, use, processing, storage, transportation and disposal and should not be considered as obligation in respect of warranty of (technical) performance, quality (specification) or suitability for any particular application. It is strongly recommended that prospective users test a sample of product under their own conditions to satisfy themselves of its suitability for an intended purpose and that expert advice be sought where different applications are contemplated, or where the extent of any application is in doubt. Due to our policy of continuous improvement we reserve the right to alter or amend published specification or design without prior notice. Reproduction of any part of this publication in any manner is not permitted without our prior written consent.